

## The Hub Buffet System

Introducing THE HUB. Simplicity and innovation, like never before; a magical buffet for both indoor and outdoor venues. At Eastern, we like to keep things simple. We work complex innovations into quality, yet easy-to-use products that are a delight to operate. The Hub is the newest add-on to our popular Rolling Buffets, a complement to Eastern's extensive line of chafing dishes and quality buffetware.

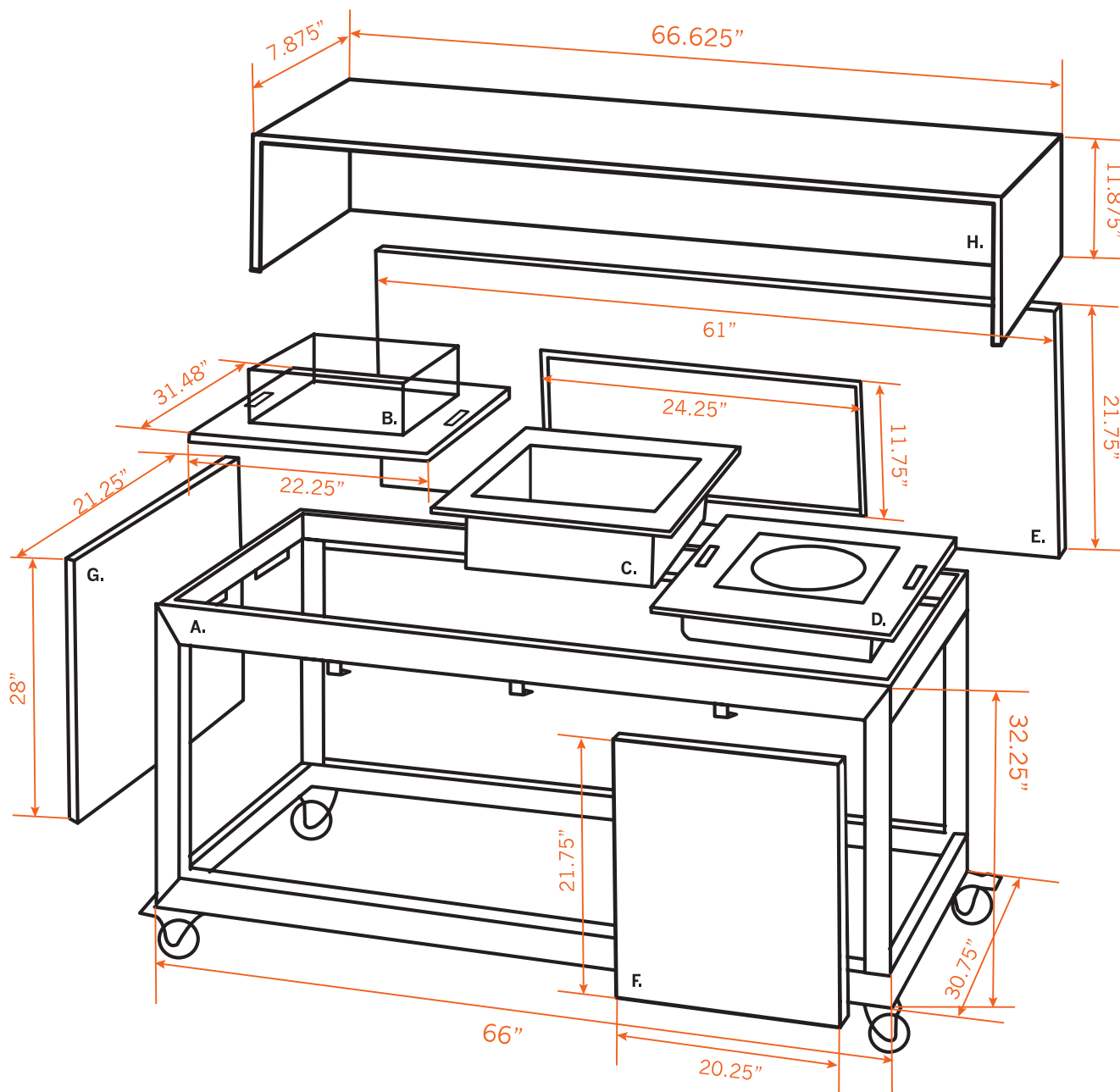

If you would like to receive our full catalog, simply send us an email at [sales@easterntabletop.com](mailto:sales@easterntabletop.com).

**A. Table Frame** 66" length, 30.7" width, 32.25" height, 100lbs  
 #ST5900 Brushed Stainless Steel | #ST5900MB Black XYLO Coated  
 #ST5900RZB Bronze XYLO Coated | #ST5900CP Copper XYLO Coated

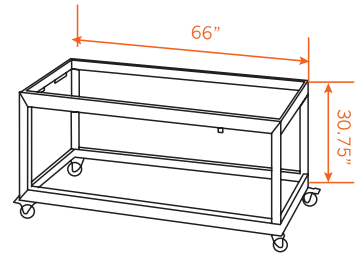

**B. Built-up Ice Bin Tile** 31.48" length, 22.25" width, .75" height, 50lbs  
 #ST5930BIB 34lbs Capacity ICE BIN: 5.5" front height, 6.5" back height

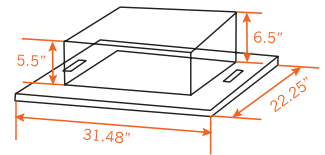

**C. Drop-in Sink Tile** 31.48" length, 22.25" width, .75" height, 8.5" deep, 55lbs  
 #ST5925DIB 84lbs Capacity | Double wall insulated stainless steel

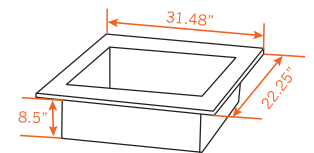

**D. Induction Tile** 31.48" length, 22.25" width, .75" height, 35lbs | IND: 15.25 length, 11.75 width  
 #ST5915IND Grey Grain | #ST5917BIND Black 110V 50/60hz 1500 Watts

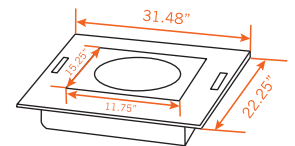

**E. Front Panel** 61" length, 21.75" width, 35lbs | WINDOW: 24.25" length, 11.75" width  
 #ST5910F Textured Laminate | #ST5912BKF Black Laminate

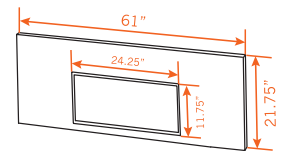

**F. Front Panel** 21.75" length, 20.25" width, 13lbs  
 #ST5966TF Textured Laminate | #ST5963BF Black Laminate  
 #ST5962SF Brushed Stainless Steel | #ST5903GF Grey Grain  
 #ST5961LEDF LED | #ST5960ACF Optic Reflector Acrylic

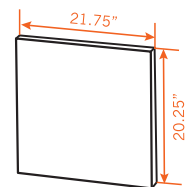

**G. Side Panels** 28" length, 21.25" width, 15lbs  
 #ST5909S Textured Laminate | #ST5908BKS Black Laminate  
 #ST5906S Brushed Stainless Steel | #ST5903GS Grey Grain  
 #ST5904LEDS LED | #ST5907ACS Optic Reflector Acrylic

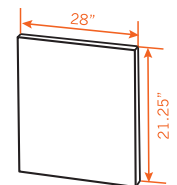

**H. Bar Top** 66.625" length, 7.875" width, 11.875" height, 35lbs  
 #ST5950BL Textured Laminate | #ST5950BAC Optic Reflector Acrylic  
 #ST5950BLSS Brushed Stainless Steel

